

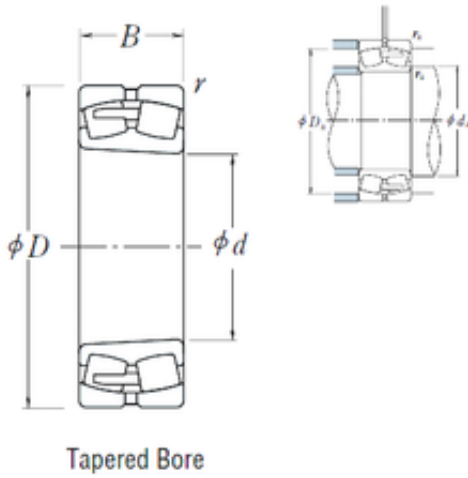

CSC BEARING GROUP limited

600 mm x 870 mm x 200 mm NSK 230/600CAKE4 Spherical roller bearing

Bearing No. 230/600CAKE4



230/600CAKE4 Bearing 2D drawings and 3D CAD models

Size	600x870x200 mm
Bore Diameter	600 mm
Outer Diameter	870 mm
Width	200 mm
d	600 mm
D	870 mm
B	200 mm
C	200 mm
r min.	6 mm
da min.	628 mm
Da min	794 mm
Da max.	842 mm
ra max.	5 mm
Weight	389 Kg
Basic dynamic load rating (C)	5450 kN
Basic static load rating (C0)	12200 kN
(Grease) Lubrication Speed	300 r/min
(Oil) Lubrication Speed	360 r/min
Calculation factor (e)	0,21
Calculation factor (Y0)	3,2
Calculation factor (Y2)	4,8