

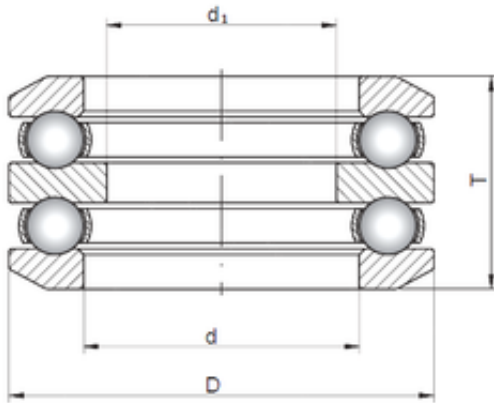

CSC BEARING GROUP limited

ISO 54317 Ball bearing



Bearing No. 54317

Size	88x150x95.2 mm
Bore Diameter	88 mm
Outer Diameter	150 mm
Width	95,2 mm
d	88 mm
d1	70 mm
D	150 mm
T	95,2 mm

54317 Bearing 2D drawings and 3D CAD models