

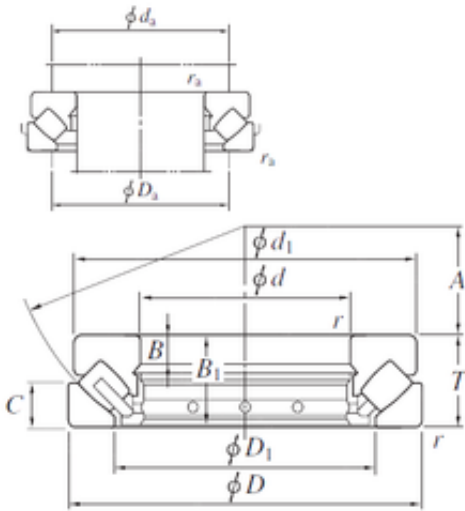

CSC BEARING GROUP limited

530 mm x 710 mm x 35 mm KOYO 292/530 Axial roller bearing

Bearing No. 292/530



292/530 Bearing 2D drawings and 3D CAD models

Size	530x710x109 mm
Bore Diameter	530 mm
Outer Diameter	710 mm
Width	109 mm
d	530 mm
D	710 mm
T	109 mm
d1	692 mm
r min.	5 mm
A	287 mm
B	35 mm
B1	105 mm
C	56 mm
D1	610 mm
da min.	615 mm
Da max.	650 mm
ra max.	4 mm
Weight	122 Kg
Basic dynamic load rating (C)	2480 kN