

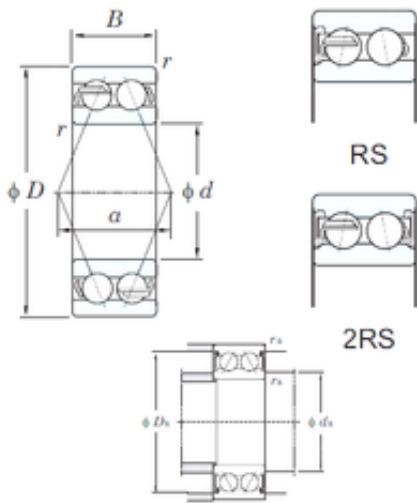

CSC BEARING GROUP limited



30 mm x 72 mm x 30.2 mm KOYO 5306-2RS
Angular contact ball bearing

Bearing No. 5306-2RS

Size	30x72x30.2 mm
Bore Diameter	30 mm
Outer Diameter	72 mm
Width	30.2 mm
d	30 mm
D	72 mm
B	30.2 mm
C	30.2 mm
a	36.2 mm
r min.	1.1 mm
da min.	37 mm
da max	41.3 mm
Da max.	65 mm
ra max.	1 mm
Weight	0.510 Kg
Basic dynamic load rating (C)	34.3 kN
Basic static load rating (C0)	25.2 kN

5306-2RS Bearing 2D drawings and 3D CAD models